

中空旋轉平台

Hollow Rotary Table



重複精度

Repetitive precision

≤ 10 arc/sec

GD MD

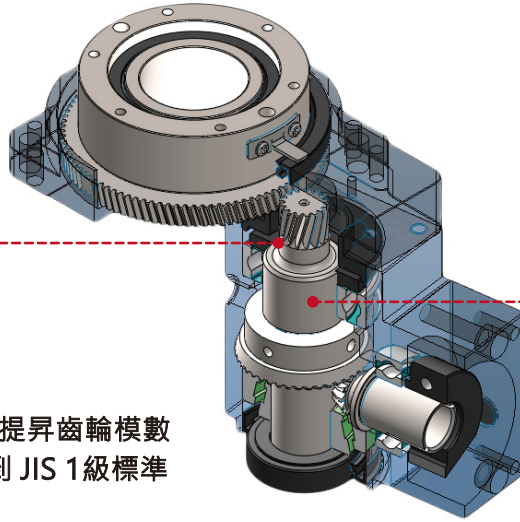

強化型齒係數

Intensive gear modulus

在MD系列的基礎上，再提昇齒輪模數、硬度及研磨精度，達到 JIS 1級標準 (原MD系列為 JIS 2級)

Based on MD series, improving gear modulus, hardness and precesion to achieve standard JIS 1.

二段減速一體化

One-piece gear ratio

小齒主軸與二段齒做同軸一體化製作，大幅提昇同心度及齒輪轉矩。

Improving concentricity and gear torque by manufacturing one-piece small gear and two section gear

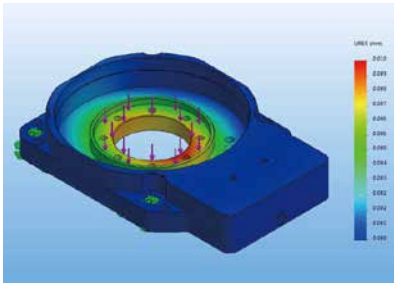

齒輪係數電腦模擬分析

Gear modulus simulate analysis

運用設計軟體設計軟體，計算齒輪的運轉力矩及模擬運轉噪音。

It is simulate for gear, hoise and intensity by software.

模數 :		為了噪音跟強度的改善，而優化齒形，齒筋形狀在理論上所產生的誤差。 ① 壓力角修整 ② 螺旋角修整 ③ 齒形Crowning修整 ④ 齒形Crowning修整(齒面修整) ⑤ BIAS修整(傾角修整) ⑥ 齒頂修整 ⑦ Relieving修整
壓力角 :		
螺旋角 :		
齒數 :		
齒深 :		
扭力 :		
回轉數 :		

材料剛性、電腦模擬分析

Material rigidity, simulate analysis

旋轉盤機體於設計時，利用軟體分析載重，轉動應力及熱變形等誤差數據分析

We rely on software which analyze loading, heat deformation data for design structure.

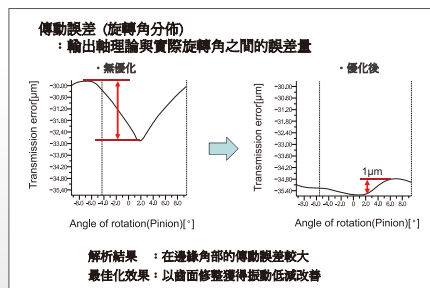

齒面設計的解析和效果的有效性

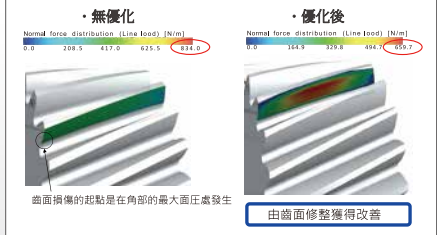

Quality control is our strategy

幾何公差檢驗

Geometric dimensioning and tolerancing inspection

使用3次元儀器，全檢旋轉台組裝後的公差數據。

In order to achieve reliable quality, we rely on the software of material, gear analysis and we have advanced equipment for inspection. Dasen guards a pass and do 100% inspection for the product.

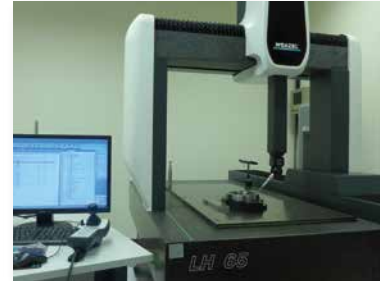

盤面精度檢測 Positioning precision inspection

<p>盤面同心度檢測</p> <p>Concentricity inspection for table</p> <p>$\leq 0.01\text{mm}$</p>	<p>盤面旋轉振幅</p> <p>Amplitude of rotation for table</p> <p>$\leq 0.005\text{mm}$</p>	<p>盤面與底座平行度</p> <p>Parallelism for table and base</p> <p>$\leq 0.015\text{mm}$</p>
--	---	--

旋轉精度檢驗

Heidenhain positioning precision inspection

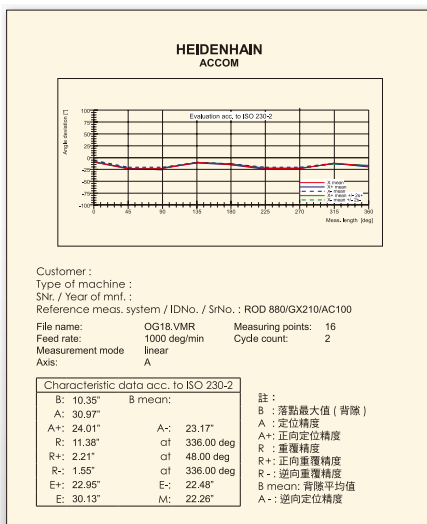

齒輪背隙及傳動精度經由“海德漢” 角度分析儀檢驗

Gear precision is inspected by
Heidenhain

GD 130 **K** - 18 **V1**

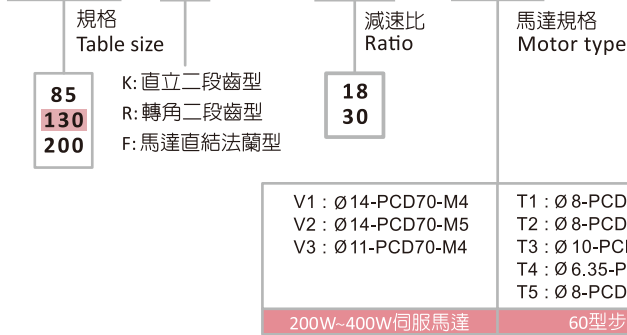

型號 / 規格 Model		GD130F-18□ GD130F-10□	GD130K-18□ GD130K-30□	GD130R-18□ GD130R-30□
容許轉矩 Max. torque	N·m	30	60	
容許徑向力 (Fr) Max. radial force	N·m	60		
減速比 Gear ratio	i	10 18	18 30	18 30
定位精度 (相對) Positioning precision	arc-sec	±20	±60	±30
重複精度 Repetitive precision	arc-sec	≤ 10	≤ 60	≤ 40
精度壽命 Lifetime of precision	hr	> 20000		
保護等級 Protection rating		IP40		
允許環境溫度 Temperature		0°C ~ +60°C		
質量 Weight	kg	2.5	3.5	3.5

· 原點Sensor規格(選購) OMRON EE-SX672

盤面精度檢測 Positioning precision inspection

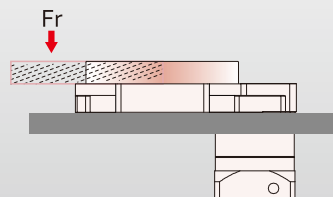
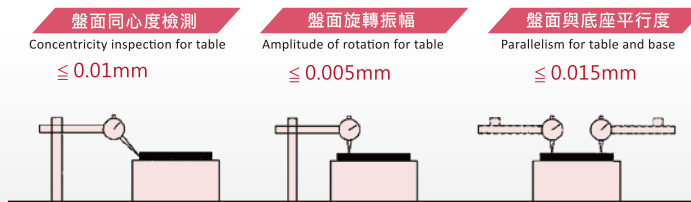

特別需求 Special request

- ▲ 盤面旋轉振幅，可製作 ≤ 0.005 mm 精度，請各別洽談
- ▲ 盤面旋轉振幅，可製作 ≤ 0.002 mm 精度，請各別談
- ▲ 盤面平行度，可製作 ≤ 0.002 mm 精度，請各別洽

The customization of ≤0.002mm rotation amplitude / ≤0.002mm parallelism is also available. For special needs, please contact with us.

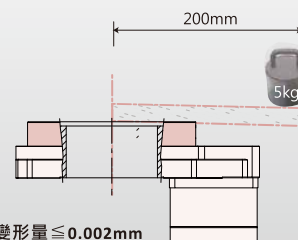

盤面平行度變形量 ≤ 0.002mm
Table parallelism deformation ≤ 0.002mm

GD130R

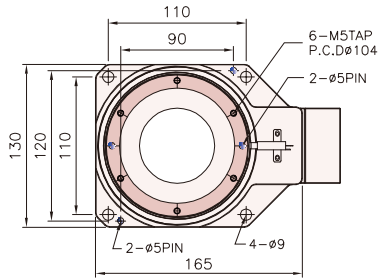

型號識別	
GD130R-18V1	GD130R-18T1
GD130R-18V2	GD130R-18T2
GD130R-18V3	GD130R-18T3
	GD130R-18T4
	GD130R-18T5

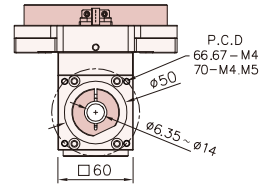
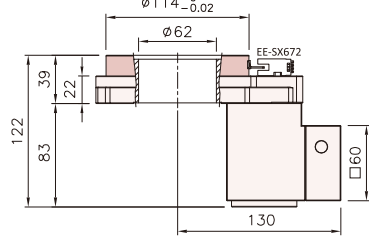

GD130R-L

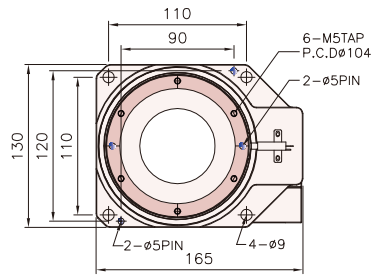

型號識別	
GD130R-L18V1	GD130R-L18T1
GD130R-L18V2	GD130R-L18T2
GD130R-L18V3	GD130R-L18T3
	GD130R-L18T4
	GD130R-L18T5

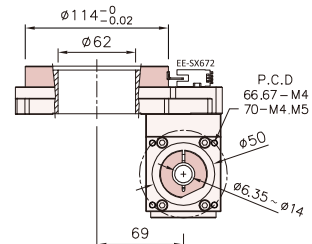
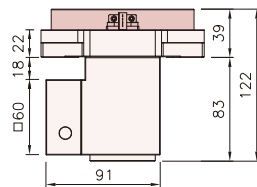

GD130R-R

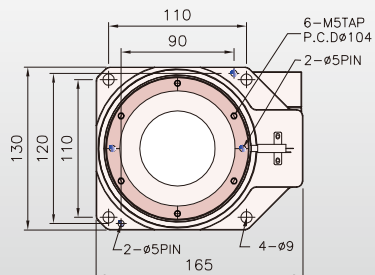

型號識別	
GD130R-R18V1	GD130R-R18T1
GD130R-R18V2	GD130R-R18T2
GD130R-R18V3	GD130R-R18T3
	GD130R-R18T4
	GD130R-R18T5

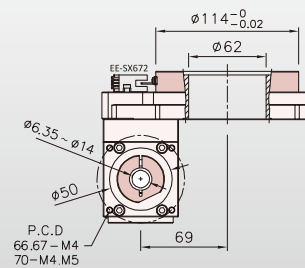
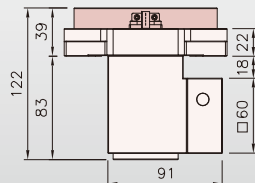

GD130FR

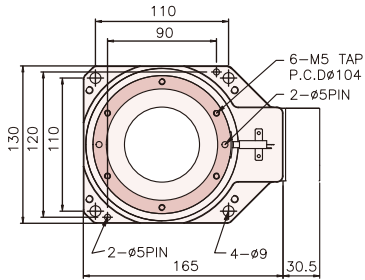

型號識別	
GD130FR-30V1	GD130FR-30T1
GD130FR-30V2	GD130FR-30T2
GD130FR-30V3	GD130FR-30T3
	GD130FR-30T4
	GD130FR-30T5

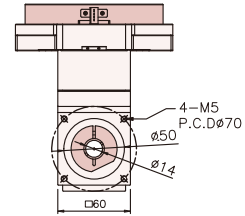
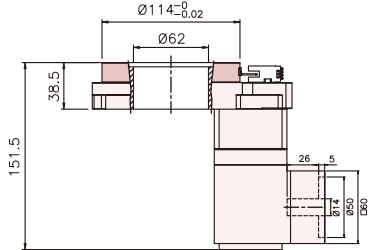

GD130FR-L

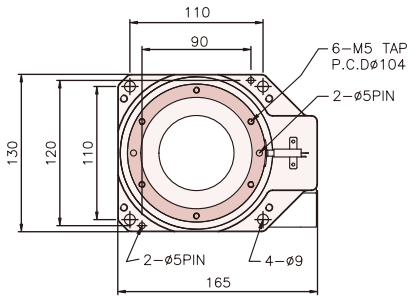

型號識別	
GD130FR-L30V1	GD130FR-L30T1
GD130FR-L30V2	GD130FR-L30T2
GD130FR-L30V3	GD130FR-L30T3
	GD130FR-L30T4
	GD130FR-L30T5

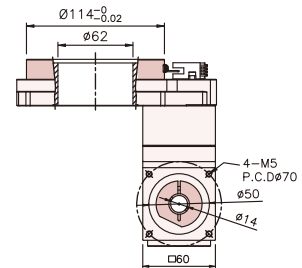
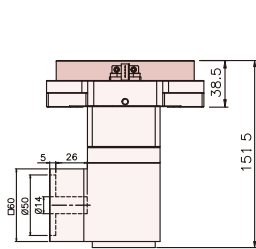

GD130FR-R

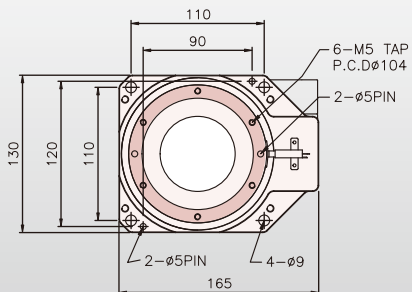

型號識別	
GD130FR-R30V1	GD130FR-R30T1
GD130FR-R30V2	GD130FR-R30T2
GD130FR-R30V3	GD130FR-R30T3
	GD130FR-R30T4
	GD130FR-R30T5

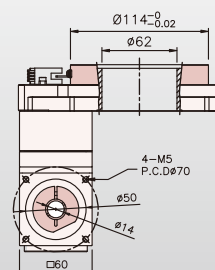
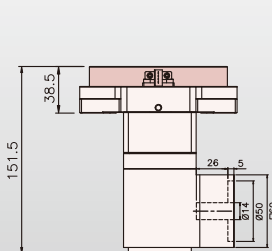

GD130K

型號識別			
GD130K-18V1	GD130K-18T1	GD130K-30V1	GD130K-30T1
GD130K-18V2	GD130K-18T2	GD130K-30V2	GD130K-30T2
GD130K-18V3	GD130K-18T3	GD130K-30V3	GD130K-30T3
	GD130K-18T4		GD130K-30T4
	GD130K-18T5		GD130K-30T5

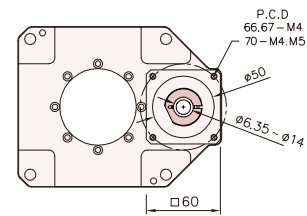
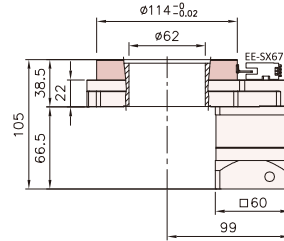
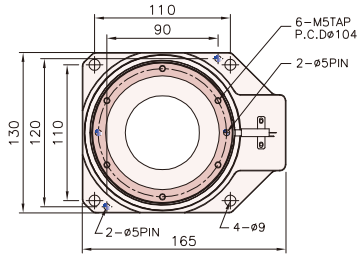

GD130F

型號識別	
GD130F-10V1	GD130F-18T1
GD130F-10V2	GD130F-18T2
	GD130F-18T3
	GD130F-18T4
	GD130F-18T5
馬達不限	限搭配 56 / 60 型 步進馬達

